

REVELANDO SÃO PAULO - 2026

APRENDI COM MEUS AVÓS

TRÍPTICO

CORES:

estrutura metálica: PRETA

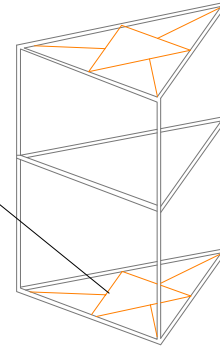

reforço inferior
(barra chata)
SOBRE O QUAL SERÁ
APOIADO O LASTRO EM
SACOS DE PEDRISCO

ILUSTRAÇÃO ESQUEMÁTICA

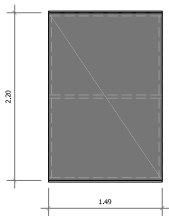

VISTA FRONTAL
1.49 x 2.20m

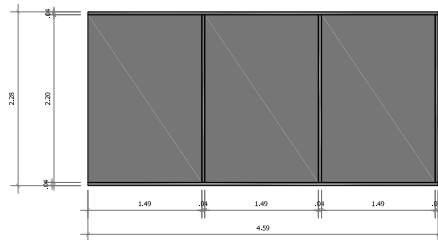

VISTA TECIDO PARA 3 IMAGENS
(abraçando a estrutura)
dimensão total: 4.59 x 2.28m

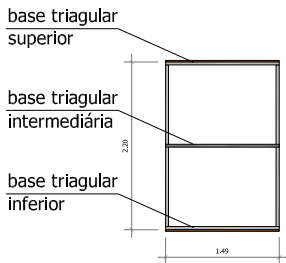

VISTA 1
TRÍPTICO
(3 faces 1.49 x 2.20m)

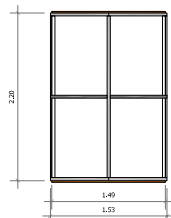

VISTA 2

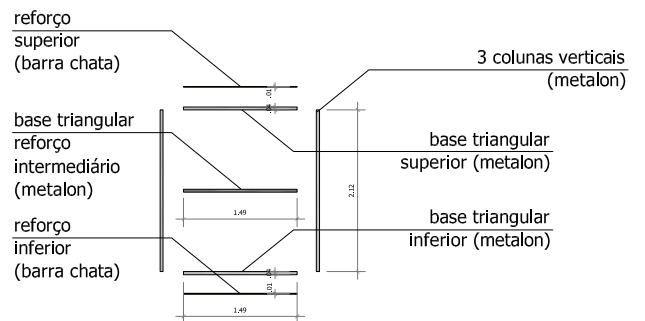

CORTE ESTOURADO

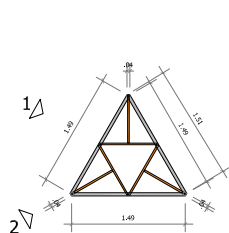

PLANTA
COMPLETA
TRÍPTICO
(3 faces de 1.49m)

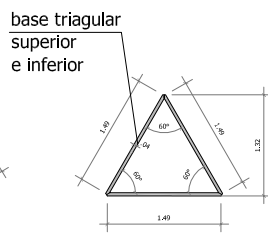

PLANTA
BASE METALON
(40x40mm)

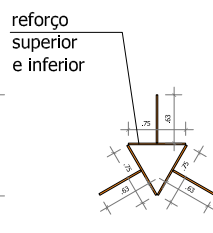

PLANTA
ESTRUTURA
BARRA CHATA
(22x10mm)

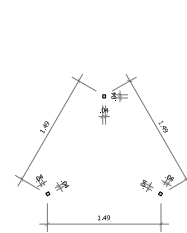

PLANTA
COLUNAS VERTICAIS
METALON (40x40mm)

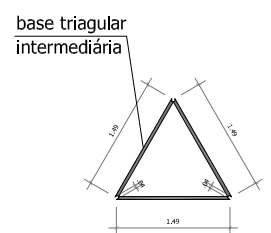

PLANTA
REFORÇO INTERMEDIÁRIO
METALON (40x40mm)